

USER MANUAL



Thank you for choosing Better Bathrooms.
Please read this manual before installing your product
and keep for future reference.



Product name – Concealed Shower Valve

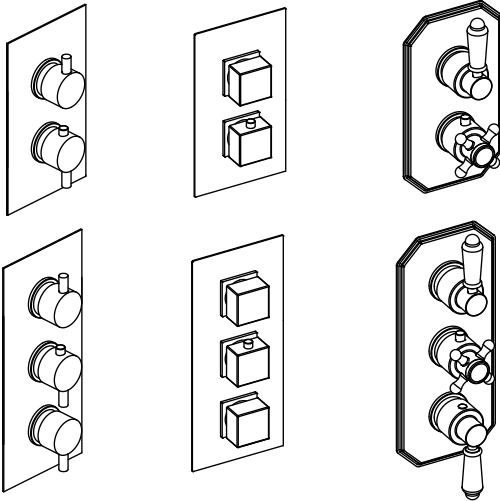

- **Single-person assembly**
- **We always recommend using professional trades people to install your product**

V2_14.03.2024

1

Congratulations on your purchase

And welcome to our growing gang of savvy shoppers
We're on a mission to bring you extraordinary bathroom products, for less. From modern to traditional style ceramics, plus the gorgeous fixtures, fittings and furniture to match. So, you can fall in love with your space every single day.
As one of the UK's largest independent bathroom stores, we've received countless awards; including the National Business Awards UK, the Digital Entrepreneur Awards and being placed on The Sunday Times Fast Track 100.
We hope your new product exceeds your highest expectations. However, if you experience any problems, please:

- call our friendly UK call centre on 03303903062 (9am-7pm Monday to Friday, or 10am-4pm Saturday and Sunday), or
- send us a message via customerservices@buyitdirect.co.uk

Important information

- Please read these instructions thoroughly and retain for future reference
Water pressures must be balanced. Always ensure to flush the system prior to installation.
Always check walls for pipes and cables before drilling.

Maximum Static Pressure 10 bar
Maximum Working Pressure 5 bar
Minimum Working pressure 0.5 bar
Hot water supply – 55-65c
Cold water supply – 5-25c

Parts/ Diagrams

TWIN VALVE:

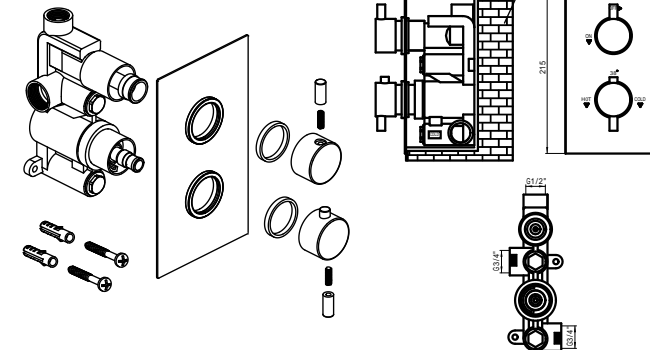

2

TWIN VALVE:

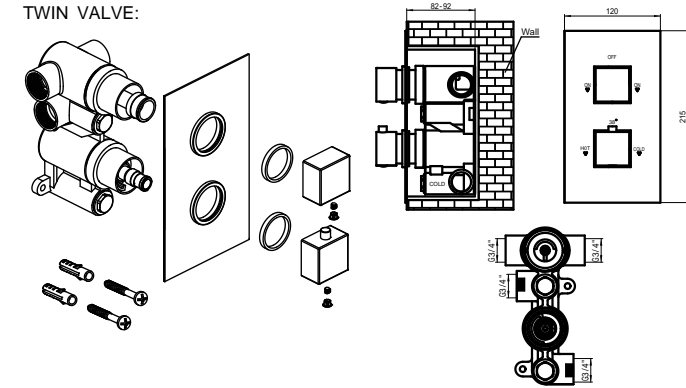

TRIPLE VALVE:

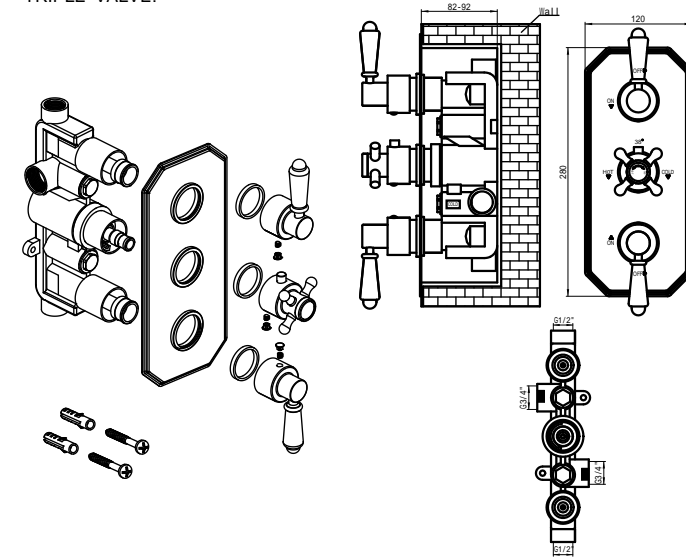

3

TRIPLE VALVE:

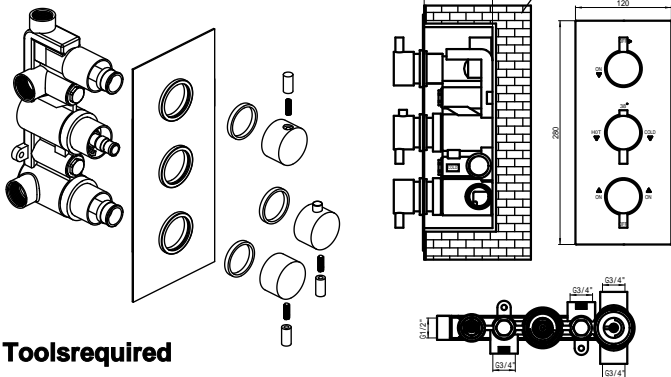

Toolsrequired

- Protective cloth

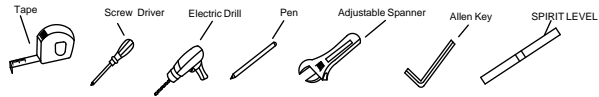

Installation

1. Determine the location of the shower valve.
Create the recess in the wall to accommodate the mixer being installed.
Mark the installation holes through the lugs in the mixer body.
Drill the holes.
Insert the wall plugs.
Secure the mixer into position using the screws provided
Connect the inlet and outlet pipe work to the mixer using an adequate sealing method.
Turn on the water supply and check for leaks before fitting the cover plate.

TWIN VALVE:

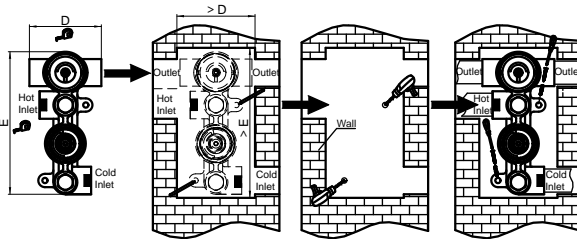
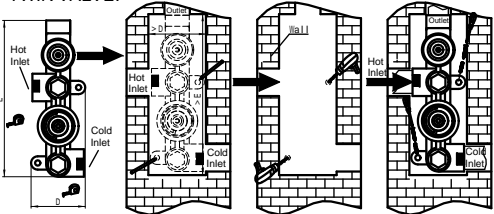

TRIPLE VALVE:

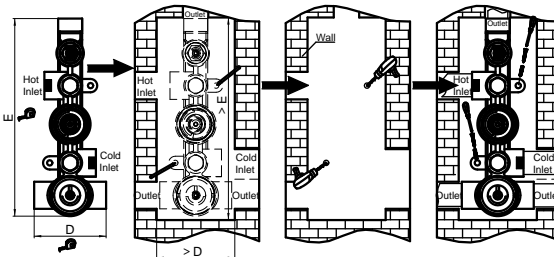
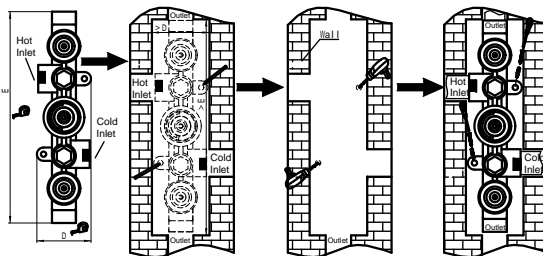

2. Once checked, install the cover plate, silicone should be applied between the plate and the wall, push this onto the mixer, ensuring correct orientation, so that the markings match the control on the mixer

Finally install the handle assembly, by fitting the handle to the valve, then tighten the retaining screw, followed by the peg or cover cap

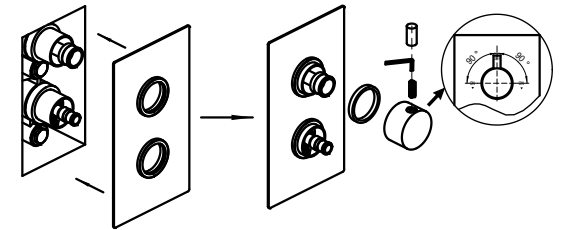

3. To ensure correct temperature setting, Face A on the stop ring should be aligned with the mark on the thermostatic cartridge, if it is not, align these by turning the spindle before fitting the handle

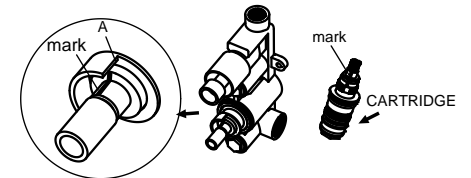

4. Once the marks are aligned place the handle onto the thermostat so that lug B on the inside of the handle sits against Face A on the stop ring, once the handle is fitted onto the thermostat, turn the handle towards cold, then back to the 38c position, if the correct alignment has been achieved you will need to press the button and continue turning to go beyond the 38c stop position.

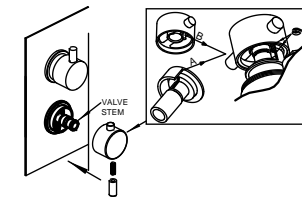

OPERATION

To open the mixer, turn on/off handle anti-clockwise.
To close the mixer, turn on/off handle clockwise.

To decrease temperature, turn the temperature control handle clockwise.
To increase temperature, turn the temperature control handle anti-clockwise.

RECALIBRATE

The temperature control handles on this product are factory set and should require no adjustment.

However, if for any reason the handles and/or the cartridge is removed, it is important the following procedures are followed.

TROUBLE SHOOTING

1. Output water temperature does not correspond with temperature set

Cause: Thermostat has not been adjusted base on the existing home water system

Remedy: Adjust the thermostat , refer to “ TemperatureSetting” procedure.

Cause: Hot Water temperature too low.

Remedy: Adjust the water heater , increase hot water temperature to 65 °C.

2. Crossflow, cold water being forced into hot water pipe, or vice versa, when valve is closed

Cause: Non-return valves dirty or leaking

Remedy: Clean the non-return valves or exchange if necessary

3. Very low flow or no flow

Cause: Supply pressure inadequate

Remedy: Check hot and cold feeds . If a pump has been installed, please check to see if the pump is working.(the valve will shut down if either the cold or hot water supply fails)

4. Water will not run hot enough when first installed

Cause: Wrong maximum temperature setting

Remedy: Adjust the maximum temperature , refer to “ TemperatureSetting” procedure.

Maintenance

After a period of use, debris or limescale can build up around the filters of the thermostat or the non-return valve, which will affect the performance of the product.

To resolve this, remove the thermostat or non-return valve from the mixer and clean.

Turn off the water supply and turn on the mixer, to drain any water inside

Maintenance (Filter)

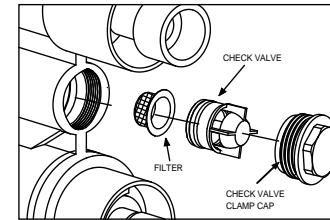

- 1) Remove the check valve clamp cap.
- 2) Use pliers to remove the check valve and filter .
- 3) Wash the filter with clean running water, dry and lightly grease the seals. (only use silicone grease).
- 4) Put back the filter and check valve, then tighten the clamp cap.

Maintenance (Thermostatic Cartridge)

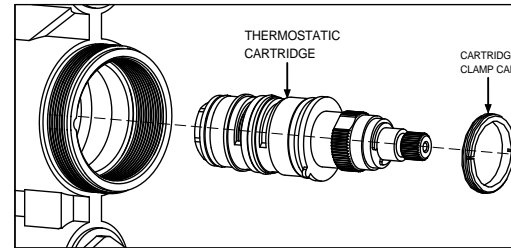

The concealed thermostatic cartridges should give trouble free service, but in the event of failure, servicing is straight forward.

- 1) Remove the cartridge clamp cap .
- 2) Pull out the thermostatic cartridge.
- 3) Wash the thermostatic cartridge with clean running water, dry and lightly grease the seals (only use silicone grease).
- 4) Put back the thermostatic cartridge, then tighten the clamp cap.

CLEANING

To maintain the surface of your product, wipe with a clean damp cloth and wipe dry. Do not use abrasive cleaning agents or materials which can strip and scratch the surface; the use of these agents or materials can invalidate your guarantee. It is recommended to wipe and dry on a regular basis.

For more information

• visit betterbathrooms.com

• email customerservices@buyitdirect.co.uk

• call 03303903062

• write to Trident Business Park, Neptune Way, Huddersfield, HD2 1UA

**better
bathrooms**

Part of the BuyItDirect Group